

NUMERI UTILIZZATI	
Inizio	1
Fine	33
Ultimo	39

TMZ

Alseno (PC) Italia  
Tel. 0523/949491 Fax 0523/949968

DIS. N.: 80001568  
CAD: SPAC  
N. FILE: 1568  
RESPONSABILE: ZONI

MACCHINA/IMPIANTO  
W8  
DIMOSTRATIVO  
DENOMINAZIONE - POTENZA  
DATA 03/97 AGG. 18/06/1998

DISTINTA  
80001568  
COMMESSA  
90001568  
ESECUTORE  
BONATTI



FOGLIO  
1  
TOTALE  
43

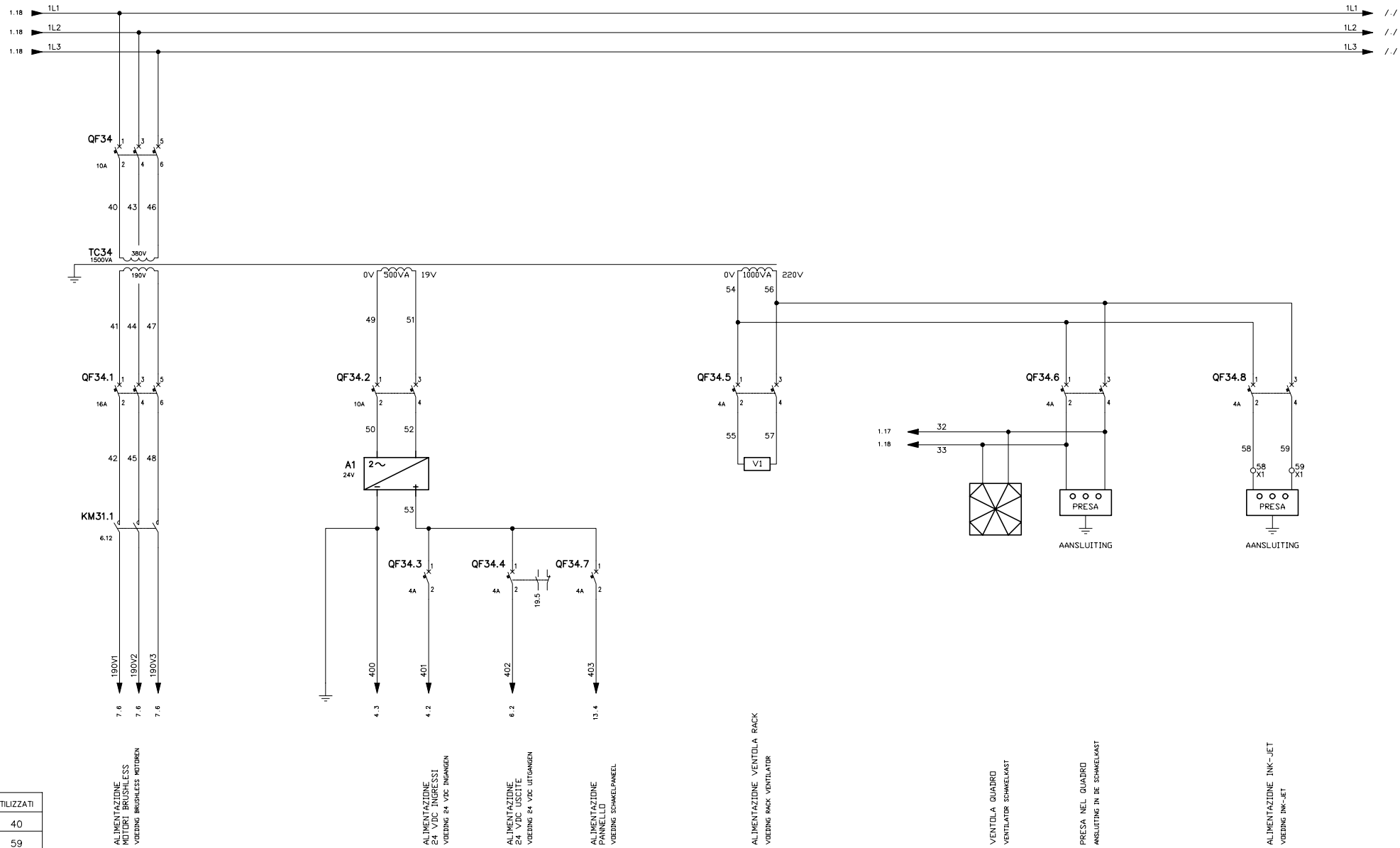

NUMERI UTILIZZATI	
Inizio	40
Fine	59
Ultimo	62

ALIMENTAZIONE  
MOTORI BRUSHLESS  
VOEDING BRUSHLESS MOTOREN

ALIMENTAZIONE  
24 VDC TRASFORMATTORE  
VOEDING 24 VDC UTGANGEN

ALIMENTAZIONE  
24 VDC USCITE  
VOEDING 24 VDC UITGANGEN

ALIMENTAZIONE  
PANNELLO  
VOEDING SCHAKELPANEEL

ALIMENTAZIONE VENTILATA RACK  
VOEDING RACK VENTILATOR

VENTILATA QUADRO  
VENTILATOR SCHAKELKAST

PRESA NEL QUADRO  
ANSLUITING IN DE SCHAKELKAST

ALIMENTAZIONE INK-JET  
VOEDING INK-JET

# TMZ

Alseno (PC) Italia  
Tel. 0523/949491 Fax 0523/949968

DIS. N.: 80001568  
CAD: **SPAC**  
N. FILE: 1568  
RESPONSABILE: ZONI

MACCHINA/IMPIANTO  
**W8  
DIMOSTRATIVO**  
DENOMINAZIONE — TRASFORMATTORE  
DATA 03/97 AGG. 18/06/1998

DISTINTA  
80001568  
COMMESSA  
90001568  
ESECUTORE  
BONATTI



FOGLIO  
**3**  
TOTALE  
**43**

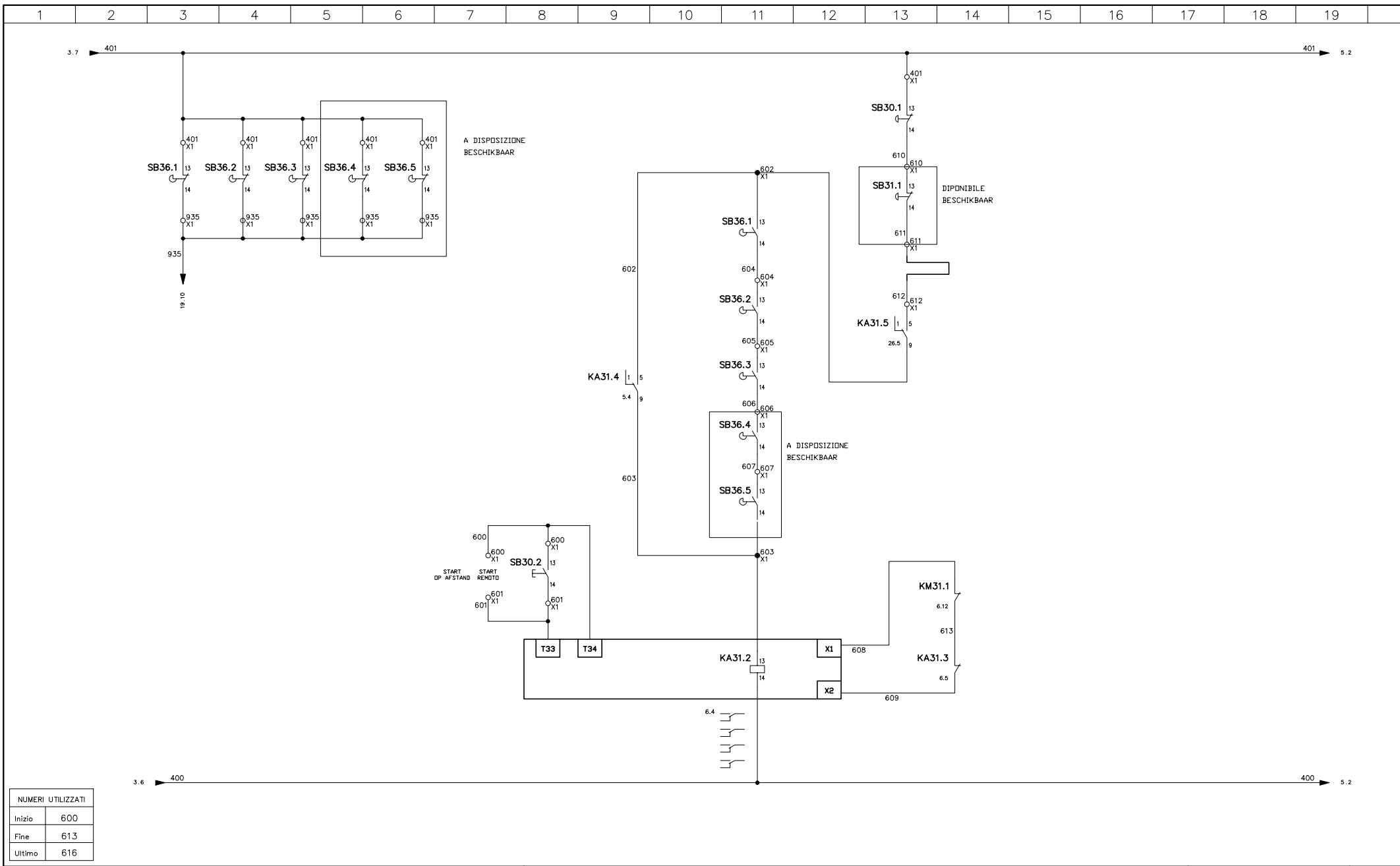

NUMERI UTILIZZATI	
Inizio	600
Fine	613
Ultimo	616

# TMZ

Alseno (PC) Italia  
Tel. 0523/949491 Fax 0523/949968

DIS. N.: **80001568**  
CAD: **SPAC**  
N. FILE: 1568  
RESPONSABILE: ZONI

MACCHINA/IMPIANTO  
**W8**  
**DIMOSTRATIVO**  
DENOMINAZIONE — **RELE DI MARCIA**  
DATA **03/97** AGG. **18/06/1998**

DISTINTA  
**80001568**  
COMMESSA  
**90001568**  
ESECUTORE  
**BONATTI**



FOGLIO  
**4**  
TOTALE  
**43**

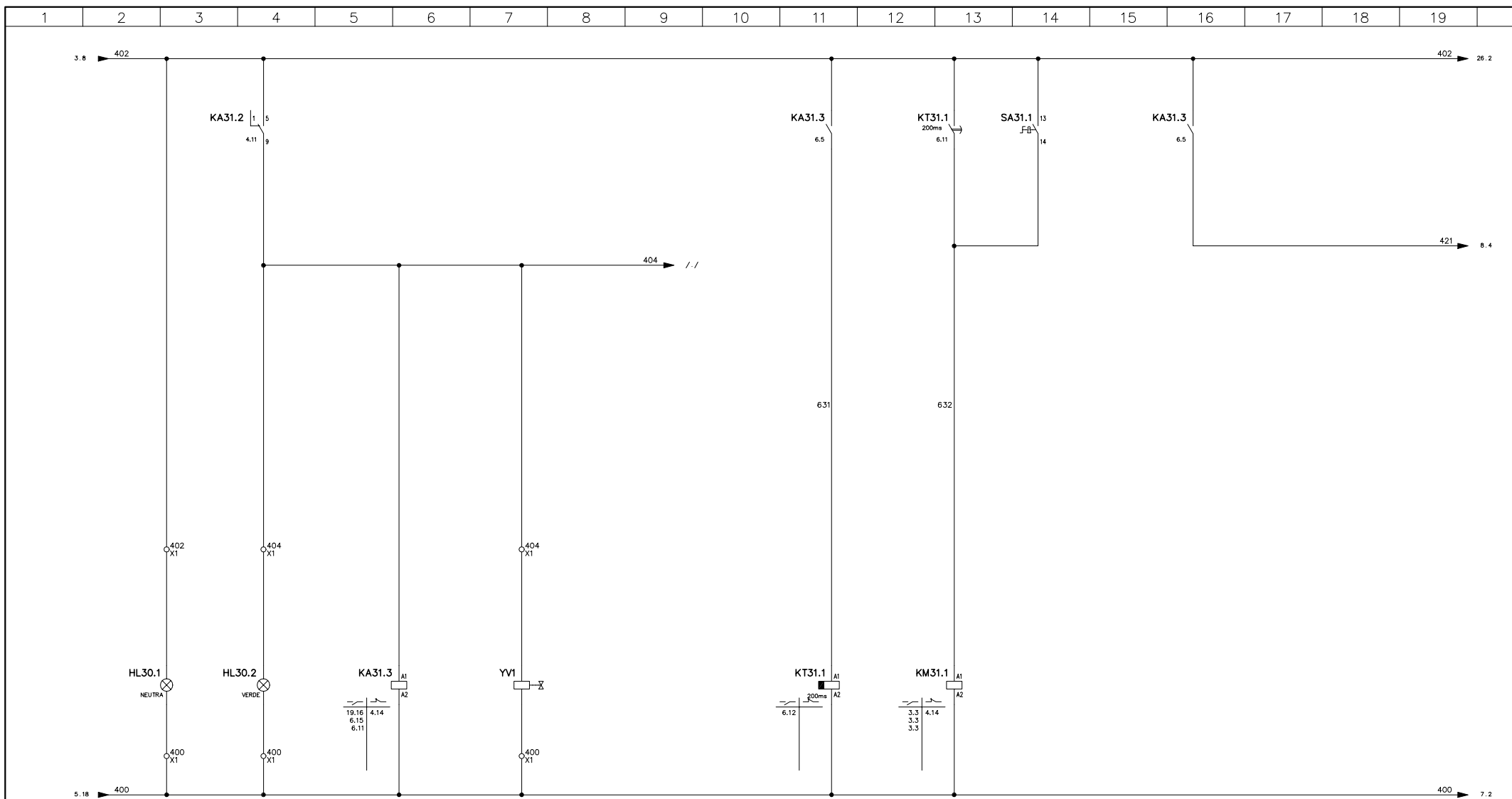

NUMERI UTILIZZATI	
Inizio	631
Fine	632
Ultimo	635

LAMPADA DI RETE  
NETZLELAPPE

LAMPADA DI MARCIA  
VERKINGSSCHWELAR

TELERUTTORE DI MARCIA  
VERKINGSSCHWELAR

E.V. SCARICO ARIA  
EV. LICHTAVER

TIMER CADUTA MARCIA  
TIMER BUTEN VERKING

TELERUTTORE  
ABBLITAZIONE  
AZIONAMENTI  
AFTANSSCHWELAR VERLEAVE  
ANRIJLF SYSTEMEN

**TMZ**  
 Alseno (PC) Italia  
 Tel. 0523/949491 Fax 0523/949968

DIS. N.: **80001568**  
 CAD: **SPAC**  
 N. FILE: 1568  
 RESPONSABILE: ZONI

MACCHINA/IMPIANTO  
**W8**  
**DIMOSTRATIVO**  
 DENOMINAZIONE — DOPO MARCIA  
 DATA 03/97 AGG. 18/06/1998

DISTINTA  
 80001568  
 COMMESSA  
 90001568  
 ESECUTORE  
 BONATTI



FOGLIO  
**6**  
 TOTALE  
**43**

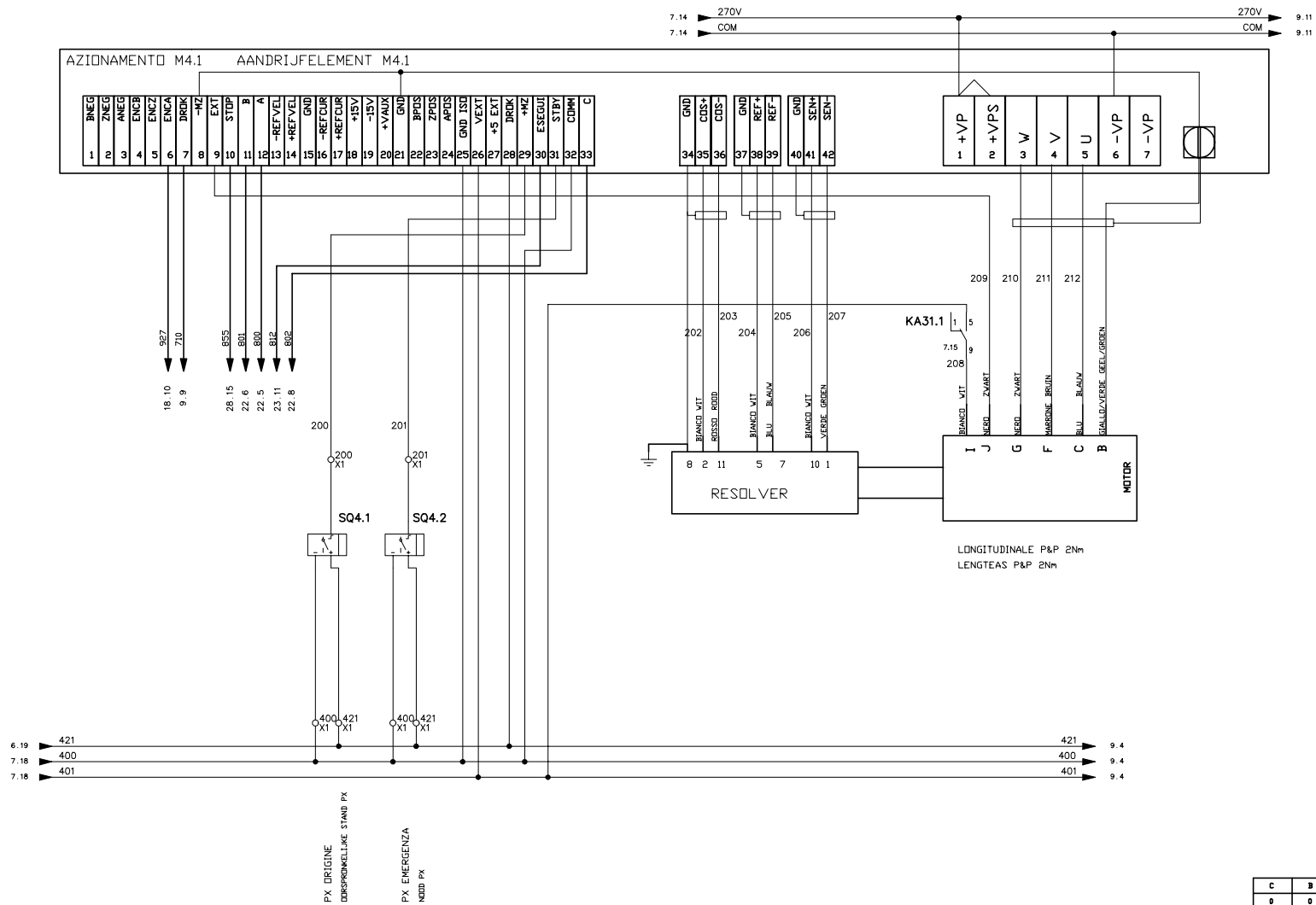

NUMERI UTILIZZATI	
Inizio	200
Fine	212
Ultimo	215

C	B	A	PROFILI
0	0	0	ESECUZIONE PROFILO 0
0	0	1	ESECUZIONE PROFILO 1
0	1	0	ESECUZIONE PROFILO 2
0	1	1	ESECUZIONE PROFILO 3
1	0	0	ESECUZIONE PROFILO 4
1	0	1	ESECUZIONE PROFILO 5
1	1	0	ESECUZIONE PROFILO 6
1	1	0	ESECUZIONE PROFILO NONE

**TMZ**  
 Alseno (PC) Italia  
 Tel. 0523/949491 Fax 0523/949968

DIS. N.: **80001568**  
 CAD: **SPAC**  
 N. FILE: 1568  
 RESPONSABILE: ZONI

MACCHINA/IMPIANTO  
**W8**  
**DIMOSTRATIVO**  
 DENOMINAZIONE — AZIONAMENTO ASSE LONGITUDINALE P&P —  
 DATA 03/97 AGG. 18/06/1998

DISTINTA  
 80001568  
 COMMESSA  
 90001568  
 ESECUTORE  
 BONATTI



FOGLIO  
**8**  
 TOTALE  
**43**

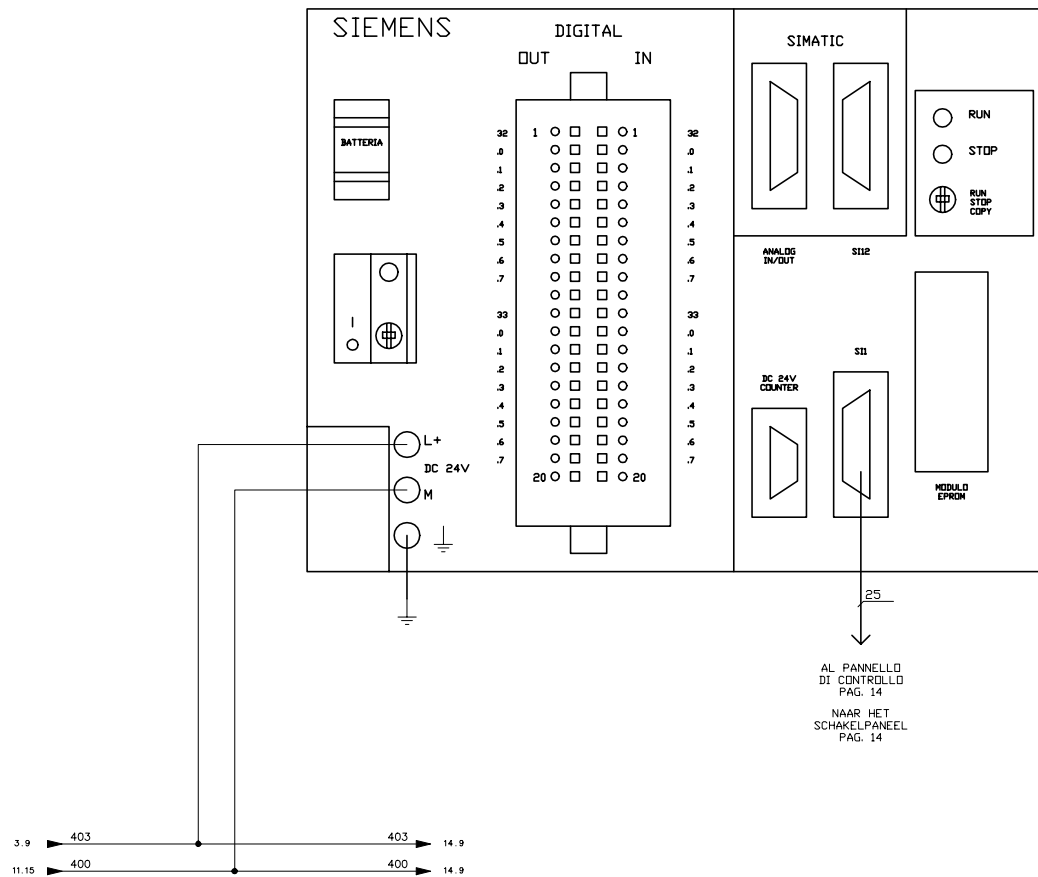

TMZ

Asleno (PC) Italia  
Tel. 0523/949491 Fax 0523/949968

DIS. N.: 80001568

CAD: SPAC

N. FILE: 1568

RESPONSABILE: ZONI

MACCHINA/IMPIANTO

W8  
DIMOSTRATIVO

DENOMINAZIONE — CPU PLC 95U SIEMENS

DATA 03/97

AGG. 18/06/1998

DISTINTA  
80001568

COMMESSA  
90001568

ESECUTORE  
BONATTI



FOGLIO

13

TOTALE

43

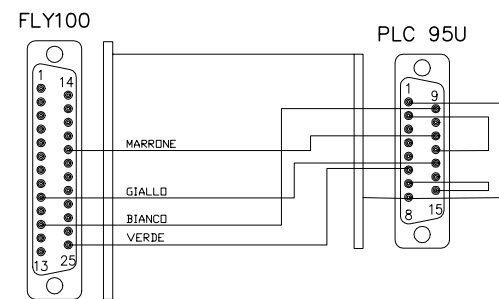
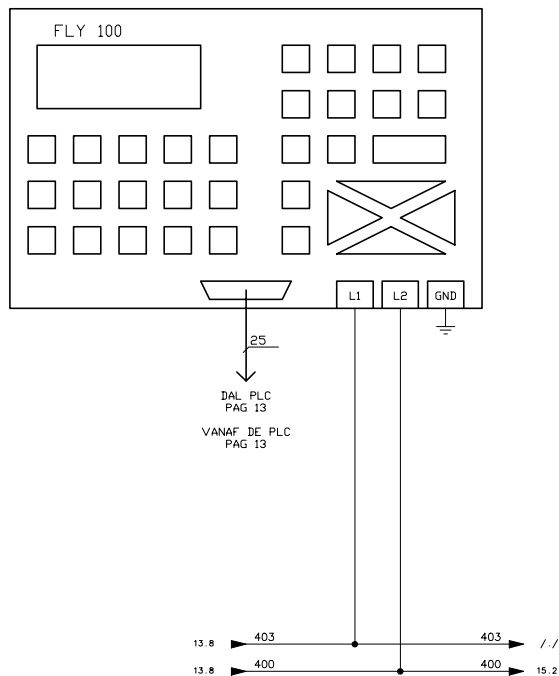

**TMZ**  
 Alseno (PC) Italia  
 Tel. 0523/949491 Fax 0523/949968

DIS. N.: **80001568**  
 CAD: **SPAC**  
 N. FILE: 1568  
 RESPONSABILE: ZONI

MACCHINA/IMPIANTO  
**W8**  
**DIMOSTRATIVO**  
 DENOMINAZIONE — PANNELLO OPERATORE  
 DATA 03/97 AGG. 18/06/1998

DISTINTA  
 80001568  
 COMMESSA  
 90001568  
 ESECUTORE  
 BONATTI



FOGLIO  
**14**  
 TOTALE  
**43**

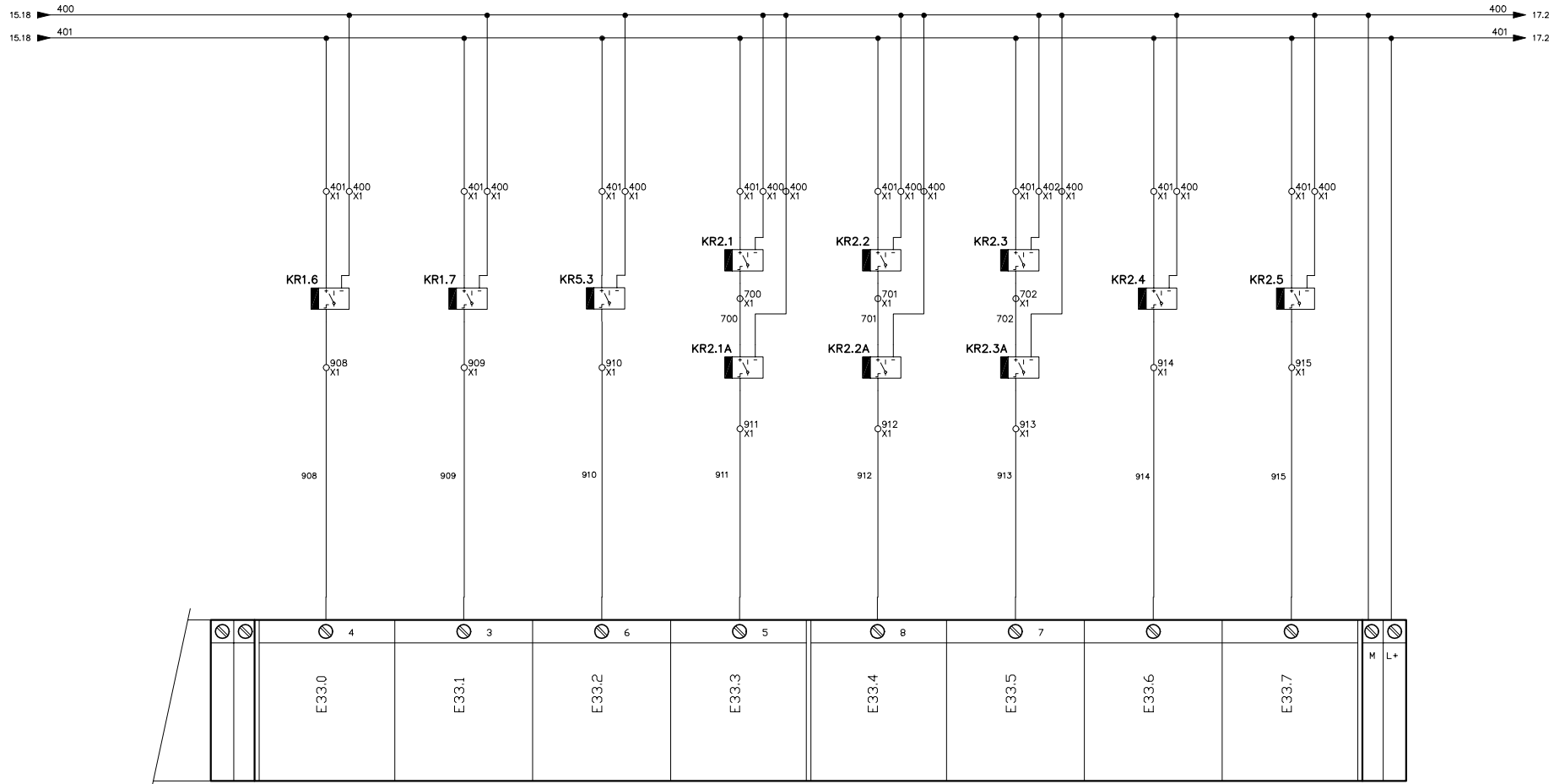

NUMERI UTILIZZATI	
Inizio	908
Fine	915
Ultimo	915

REED ROTAZIONE PRODOTTO ALTO  
REED ROTATIE PRODUKT HOG

REED ROTAZIONE PRODOTTO BASSO  
REED ROTATIE PRODUKT LAG

REED RIBALTATORE 180°

SERIE REED SRODMANENTO 1 FASE ALTO  
SERIE REED OPRICHTING DIOS 1 FASE HOG

SERIE REED SRODMANENTO 1 FASE BASSO  
SERIE REED OPRICHTING DIOS 1 FASE LAG

SERIE REED SRODMANENTO 2 FASE  
SERIE REED OPRICHTING DIOS 2 FASE

REED PRESA CARTONE ALTO  
REED WENKING DIOS HOG

REED PRESA CARTONE BASSO  
REED WENKING DIOS LAG

**TMZ**

Alseno (PC) Italia  
Tel. 0523/949491 Fax 0523/949968

DIS. N.: **80001568**  
CAD: **SPAC**  
N. FILE: 1568  
RESPONSABILE: ZONI

MACCHINA/IMPIANTO  
**W8**  
**DIMOSTRATIVO**  
DENOMINAZIONE — SECONDA SCHEDA INGRESSI CPU  
DATA 03/97 AGG. 18/06/1998

DISTINTA  
80001568  
COMMESSA  
90001568  
ESECUTORE  
BONATTI



FOGLIO  
**16**  
TOTALE  
**43**



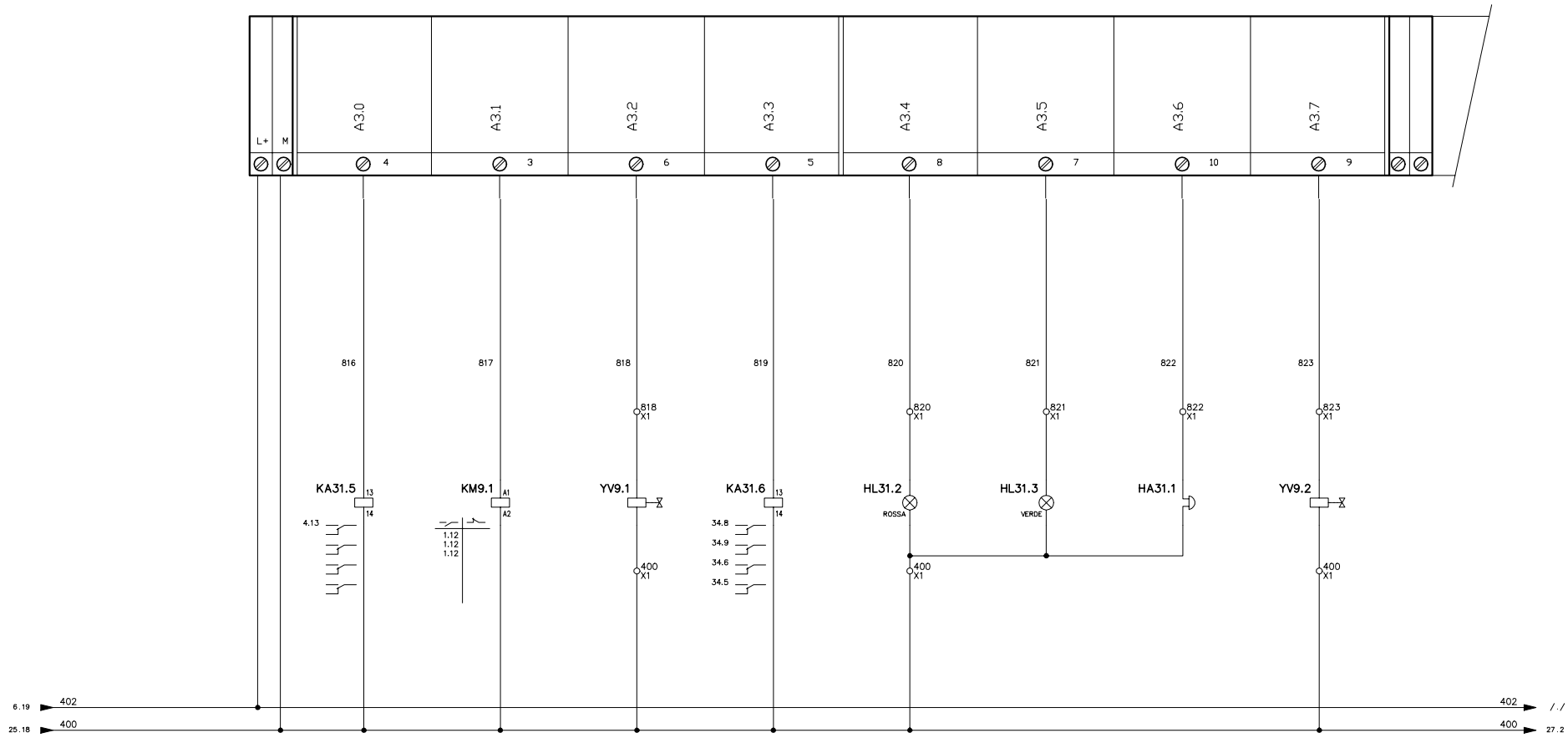

RELE BLOCCO MARCIA  
RELAIS BLOKKERING WERKING

POMPA VUOTO  
VACUUMPOMPE

EV VUOTO PINZA POSTERIORE  
EV VACUUM ACHTERSTE GRUJPER

RELE CONDENSIO MACCHINA A MONTE A VALLE  
RELAIS TIESTEMING WERKINGSMACHINE ERVOR/ERACHTER

LAMPADA A COLONNA  
ZUILLAMPJE

EV VUOTO PINZA ANTERIORE  
EV VACUUM VOORSTE GRUJPER

ROSSA  
rood

VERDE  
groen

SIFEMA  
sirene

NUMERI UTILIZZATI	
Inizio	816
Fine	823
Ultimo	823

**TMZ**  
 Alseno (PC) Italia  
 Tel. 0523/949491 Fax 0523/949968

DIS. N.:	80001568
CAD:	SPAC
N. FILE:	1568
RESPONSABILE:	ZONI

MACCHINA/IMPIANTO	
W8 DIMOSTRATIVO	
DENOMINAZIONE	— PRIMA SCHEDA USCITE
DATA	03/97
AGG.	18/06/1998

DISTINTA	80001568
COMMESSA	90001568
ESECUTORE	BONATTI



FOGLIO	26
TOTALE	43

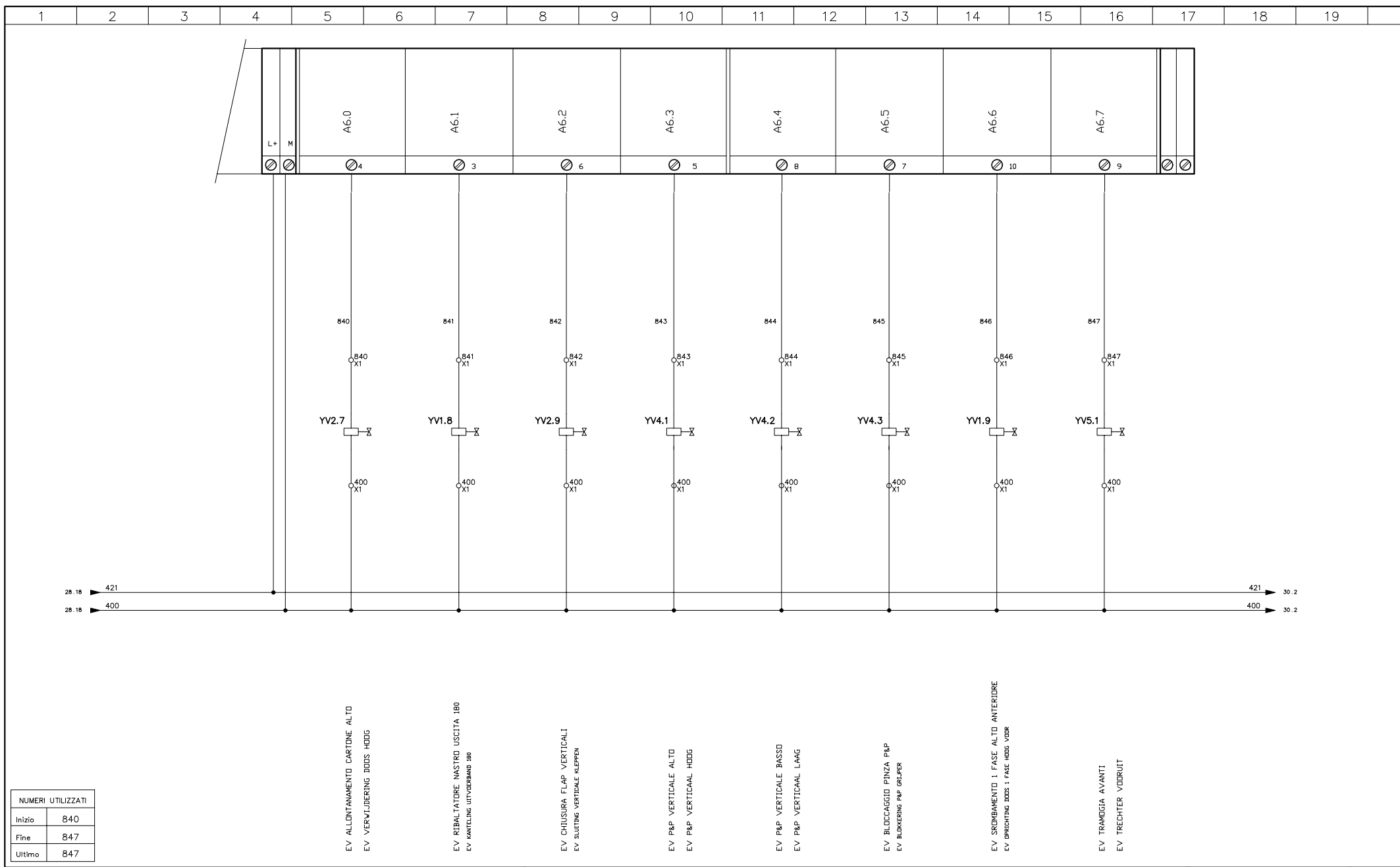

**TMZ**  
 Alseno (PC) Italia  
 Tel. 0523/949491 Fax 0523/949968

DIS. N.: **80001568**  
 CAD: **SPAC**  
 N. FILE: 1568  
 RESPONSABILE: ZONI

MACCHINA/IMPIANTO  
**W8**  
**DIMOSTRATIVO**  
 DENOMINAZIONE — QUARTA SCHEDA USCITE  
 DATA 03/97 AGG. 18/06/1998

DISTINTA  
 80001568  
 COMMESSA  
 90001568  
 ESECUTORE  
 BONATTI



FOGLIO  
**29**  
 TOTALE  
**43**

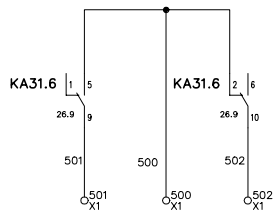

CONSENSO A  
MACCHINA A  
MONTE

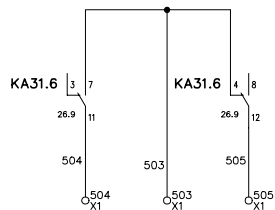

CONSENSO A  
MACCHINA A  
VALLE

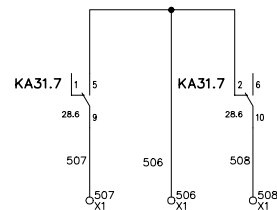

CONSENSO  
A INK-JET

NUMERI UTILIZZATI	
Inizio	500
Fine	508
Ultimo	511

**TMZ**  
 Alseno (PC) Italia  
 Tel. 0523/949491 Fax 0523/949968

DIS. N.:	<b>80001568</b>
CAD:	<b>SPAC</b>
N. FILE:	1568
RESPONSABILE:	ZONI

MACCHINA/IMPIANTO	
<b>W8 DIMOSTRATIVO</b>	
DENOMINAZIONE	— <u>CONSENSI ESTERNI</u>
DATA	03/97
AGG.	18/06/1998

DISTINTA	80001568
COMMESSA	90001568
ESECUTORE	BONATTI



FOGLIO	<b>34</b>
TOTALE	<b>43</b>

RIFERIMENTI COLORI CAVI POSA FISSA E POSA MOBILE SCHERMATI

CAVO 2X0.5  
CAVO 2X0.34

NUMERO	COLORE FILO
1	MARRONE
2	BIANCO

CAVO 4X0.20  
CAVO 4X0.34

NUMERO	COLORE FILO
1	MARRONE
2	BIANCO
3	GIALLO
4	VERDE

CAVO 6X0.20  
CAVO 6X0.34

NUMERO	COLORE FILO
1	MARRONE
2	BIANCO
3	GIALLO
4	VERDE
5	GRIGIO
6	ROSA

CAVO 12X0.20  
CAVO 12X0.34

NUMERO	COLORE FILO
1	MARRONE
2	BIANCO
3	GIALLO
4	VERDE
5	GRIGIO
6	ROSA
7	ROSSO
8	BLU
9	NERO
10	VIOLA
11	GRIGIO/ROSA
12	ROSSO/BLU

CAVO 25X0.20  
CAVO 25X0.34

NUMERO	COLORE FILO
1	MARRONE
2	BIANCO
3	GIALLO
4	VERDE
5	GRIGIO
6	ROSA
7	ROSSO
8	BLU
9	NERO
10	VIOLA
11	GRIGIO/ROSA
12	ROSSO/BLU
13	MARRONE/GIALLO
14	BIANCO/VERDE
15	BIANCO/GIALLO
16	MARRONE/VERDE
17	MARRONE/GRIGIO
18	MARRONE/ROSA
19	MARRONE/ROSSO
20	MARRONE/BLU
21	BIANCO/NERO
22	BIANCO/GRIGIO
23	BIANCO/ROSA
24	BIANCO/ROSSO
25	BIANCO/BLU

**TMZ**  
 Alseno (PC) Italia  
 Tel. 0523/949491 Fax 0523/949968

DIS. N.: **80001568**  
 CAD: **SPAC**  
 N. FILE: 1568  
 RESPONSABILE: ZONI

MACCHINA/IMPIANTO  
**W8**  
**DIMOSTRATIVO**  
 DENOMINAZIONE — **RIFERIMENTI COLORI CAVI**  
 DATA 03/97 AGG. 18/06/1998

DISTINTA  
 80001568  
 COMMESSA  
 90001568  
 ESECUTORE  
 BONATTI



FOGLIO  
**37**  
 TOTALE  
**43**

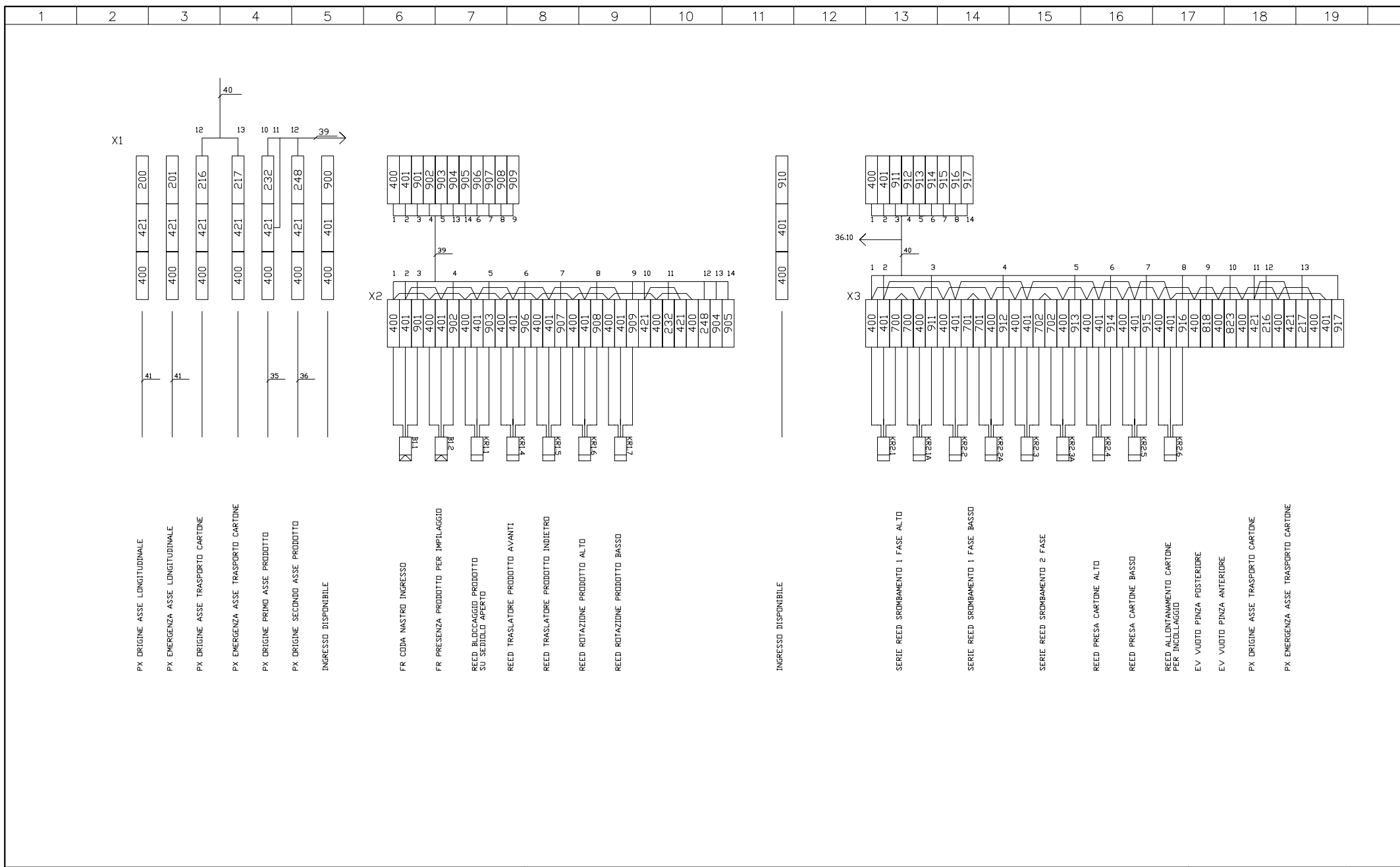

**TMZ**  
 Alseno (PC) Italia  
 Tel. 0523/949491 Fax 0523/949968

DIS. N.: **80001568**  
 CAD: **SPAC**  
 N. FILE: 1568  
 RESPONSABILE: ZONI

MACCHINA/IMPIANTO  
**W8**  
**DIMOSTRATIVO**  
 DENOMINAZIONE — **MORSETTIERE**  
 DATA 03/97 AGG. 18/06/1998

DISTINTA  
 80001568  
 COMMESSA  
 90001568  
 ESECUTORE  
 BONATTI



FOGLIO  
**40**  
 TOTALE  
**43**

LISTA FOGLI \ INDEX

Foglio Sheet	Descrizione Description	Revisione \ Revision									Foglio Sheet	Descrizione Description	Revisione \ Revision								
		0	1	2	3	4	5	6	7	8			9	0	1	2	3	4	5	6	7
1	POTENZA										28	TERZA SCHEDA USCITE									
2	LIBERO										29	QUARTA SCHEDA USCITE									
3	TRASFORMATORE										30	GIUNTA SCHEDA USCITE									
4	RELE DI MARCIA										31	SESTA SCHEDA USCITE									
5	PROTEZIONI PORTELLE ARMADIO ELETTRICO										32	LIBERO									
6	DOPD MARCIA										33	LIBERO									
7	ALIMENTATORE AZIONAMENTI										34	CONSENSI ESTERNI									
8	AZIONAMENTO ASSE LONGITUDINALE P&P										35	EV IN BATTERIA									
9	AZIONAMENTO ASSE TRASPORTO CARTONE										36	LIBERO									
10	PRIMO ASSE CATENE IMPILAGGIO PRODOTTO										37	RIFERIMENTI COLORI CAVI									
11	SECONDDO ASSE CATENE IMPILAGGIO PRODOTTO										38	LIBERO									
12	LIBERO										39	MORSETTIERE									
13	CPU PLC 95U SIEMENS										40	MORSETTIERE									
14	PANNELLO OPERATORE										41	MORSETTIERE									
15	PRIMA SCHEDA INGRESSI CPU										42	LIBERO									
16	SECONDA SCHEDA INGRESSI CPU										43	INDICI									
17	PRIMA SCHEDA INGRESSI																				
18	SECONDA SCHEDA INGRESSI																				
19	TERZA SCHEDA INGRESSI																				
20	QUARTA SCHEDA INGRESSI																				
21	QUINTA SCHEDA INGRESSI																				
22	LIBERO																				
23	LIBERO																				
24	PRIMA SCHEDA USCITE CPU																				
25	SECONDA SCHEDA USCITE CPU																				
26	PRIMA SCHEDA USCITE																				
27	SECONDA SCHEDA USCITE																				

TMZ

Alseno (PC) Italia  
Tel. 0523/949491 Fax 0523/949968

DIS. N.: 80001568

CAD: SPAC

N. FILE: 1568

RESPONSABILE: ZONI

MACCHINA/IMPIANTO

W8  
DIMOSTRATIVO

DENOMINAZIONE - INDI

DATA 03/97

AGG. 18/06/1998

DISTINTA  
80001568

COMMESSA  
90001568

ESECUTORE  
BONATTI



FOGLIO

43

TOTALE

43

